

Optosource

Optical Reflector for Bridgelux Vero 18 COB

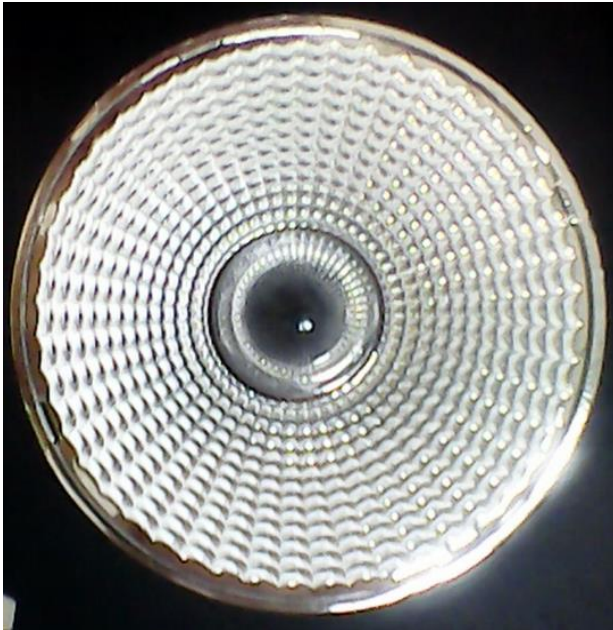

- Specially design for Bridgelux Vero 18 series LEDs.
- Reflector material metallized PC, with high UV and temperature resistance.
- Small position pins, fastening to Vero orifice with droplets glue.

Reflector Types

Order Code	FWHM Angle	Cover	Holder
BR08520-C1C-BV18	±10	With Cleaar Cover	Without Holder
BR08540-C1C-BV18	±20	With Cleaar Cover	Without Holder
BR08560-C1C-BV1318	±30	With Cleaar Cover	Without Holder

Optosource

Measurements

Relative Intensity of BR08520-C1C-BV18

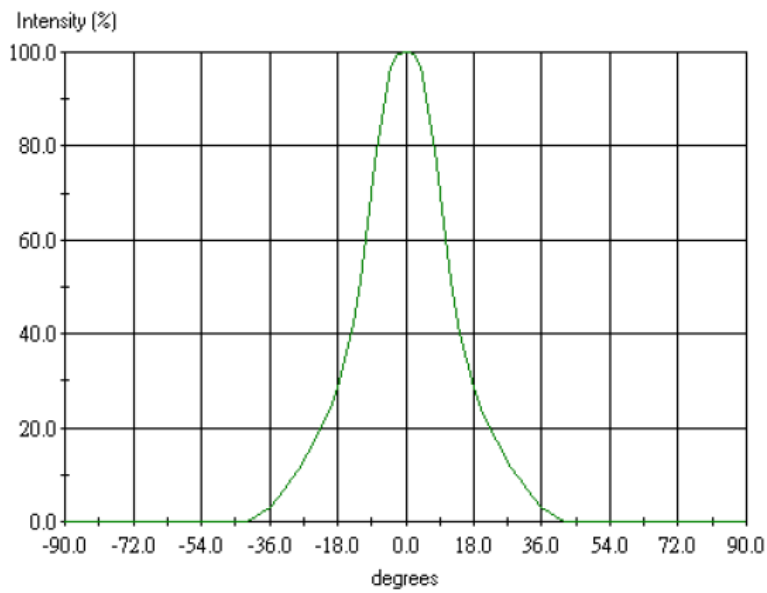

Relative Intensity of BR08540-C1C-BV18

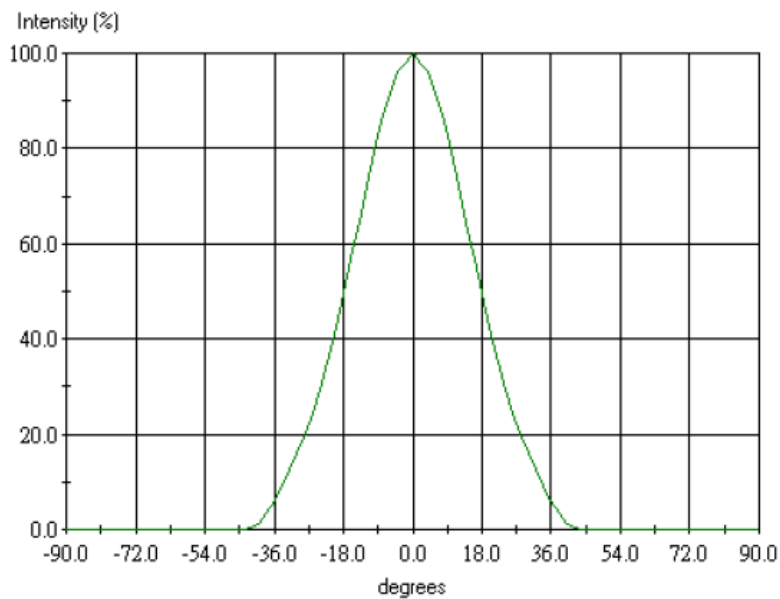

Optosource

Measurements

Relative Intensity of BR08560-C1C-BV1318

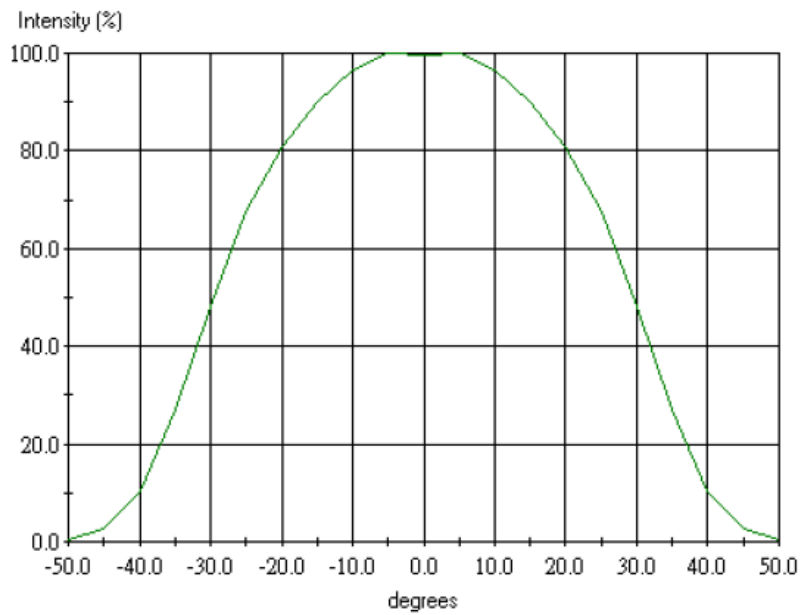

Optosource

Drawings

Reflector drawings

BR08520-C1C-BV18 / BR08540-C1C-BV18

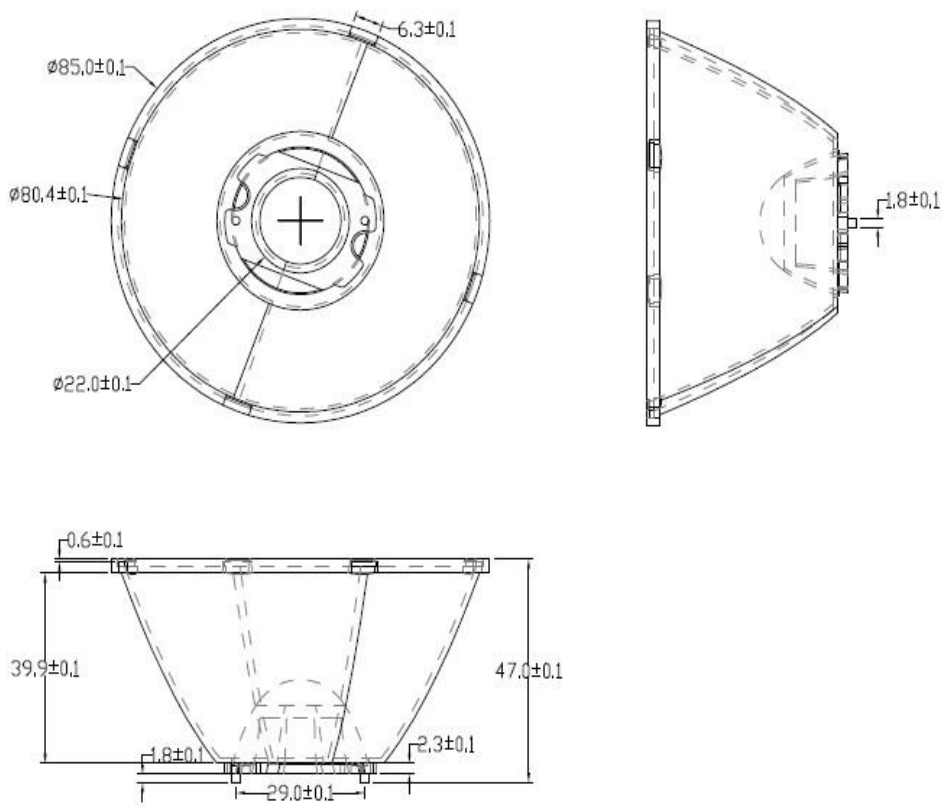

Optosource

Drawings

BR08560-C1C-BV1318

